Crimson  **Trace**™

Owner's Manual
AR15/M16

Model: LG 525

L A S E R G R I P S®

Thank you for selecting the finest laser sighting system: Crimson Trace Lasergrrips.

For speed, accuracy and security, Crimson Trace is the top choice of law enforcement, militaries and legally armed citizens around the world.

Feel free to contact us at 1.800.442.2406 with any questions you may have regarding your Lasergrrips.

We also encourage you to visit us online at ***www.crimsontrace.com***. Here you can register your product, find valuable information on training and tactics or join fellow Crimson Trace users on our online forums.

Before installing Lasergrrips, please read the entire manual.

Failure to follow these instructions and procedures may result in injury or death.

- Always follow firearms safety rules as outlined by the firearms manufacturer.
- Do not point the laser beam at eyes. Permanent eye damage can result.
- Keep this and all firearm related products locked and secured from children or other unauthorized users.

AR15/M16 LASER SYSTEM OVERVIEW

The Crimson Trace Laser for the M16 weapons system is an integrated, visible laser designator. The laser is designed to optimize capabilities in low-light and close-quarter operations. The unit replaces the standard handgrip of the firearm with an integrated grip/laser unit. The grip houses the master ON/OFF switch, battery and the activation pad. By applying pressure to the front activation switch the laser can be turned ON or OFF as tactics demand.

The laser is red visible and operates in the 633nm range. At longer ranges, this laser will not be easily visible in daylight operations.

The laser is attached to the rifle's carry handle with a cam-lock system. This cam-lock system requires no tools. The cam moves through a 90-degree arc of motion to attach or remove the laser. The laser can be removed in a matter of seconds to disassemble the rifle.

The AR15/M16 Lasergrip uses a commonly available 123 type battery which normally lasts for about 20 hours of constant ON. If the laser becomes dim or fades, replace the battery.

PARTS LIST

- A. Panel A
- B. Panel B
- C. Grip Screws

- D. Laser Retaining Bracket
- E. Laser Retaining Bracket Bolt
- F. Laser Retaining Bracket Nut
- G. Laser Retaining Bracket Hex Wrench
- H. Laser Adjustment Hex Wrenches
- I. Cleaning Swabs
- J. Laser "Danger" Sticker

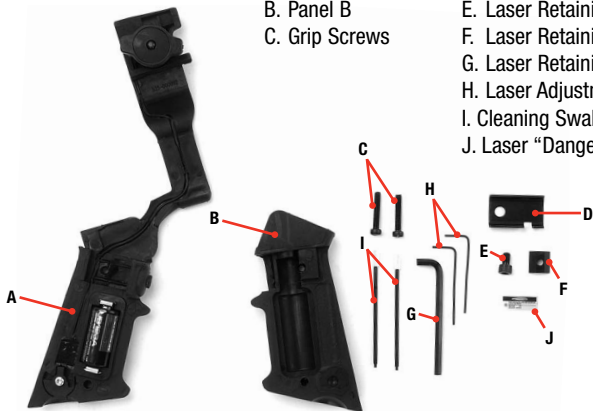

INSTALLATION INSTRUCTIONS

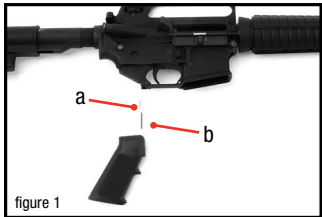

1. Check for an unloaded firearm.

Visually and physically assure that the firearm is unloaded. Check again.

2. Remove factory grip.

The selector detent (a) and selector spring (b) are retained by the grip. Take care not to lose these pieces when grip is removed. See figure 1.



3. Install panel B of laser.

Using factory hardware, install panel B of laser system. Make sure selector spring is reinstalled correctly. See figure 2.

INSTALLATION INSTRUCTIONS

4. Install laser retaining bracket.

Using the included laser retaining bracket bolt (E), loosely install the laser retaining bracket (D) to the carry handle. The laser retaining bracket nut (F) fits in the carry handle groove. This nut retains the bracket while still maintaining iron sight capability. See figure 3.

DO NOT TIGHTEN THE BRACKET AT THIS TIME!

If you are using a carry handle mounted optic, install the retaining bracket using the optic's bolt.

FIT NOTE

There are wide variances in the width of carry handles. Because of this, the laser retaining bracket may seem too narrow to fit properly. If the bracket will not go on, **VERY CAREFULLY** bend the ears of the bracket outward to allow proper fit.

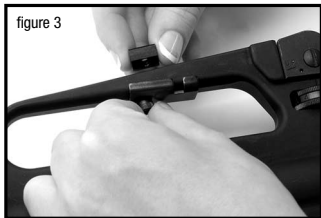

INSTALLATION INSTRUCTIONS

5. Battery installation.

Battery installs with the positive (+) side up. See figure 4.

6. Install panel A of laser.

Press panels A and B together. Screw panels together. Tighten screws snugly, but do not overtighten.

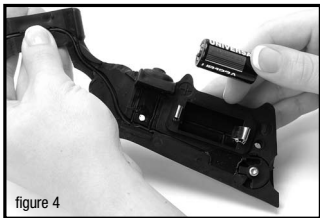

INSTALLATION INSTRUCTIONS

7. Mount laser on carry handle.

Press laser onto carry handle. Engage laser onto laser retaining bracket to ensure stability. Twist cam-lock clockwise 90-degrees to lock laser onto carry handle. See figures 5 and 6.

After the laser is engaged onto the laser retaining bracket, tighten the laser retaining bracket bolt. This ensures repeatability.



figure 5

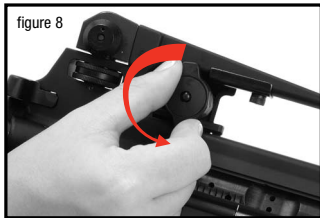

figure 6

INSTALLATION INSTRUCTIONS

8. Removing laser.

To remove laser from carry handle: press button on left side of rifle while turning cam-lock 90-degrees counter-clockwise.



SIGHTING ADJUSTMENTS

Lasergrips are pre-sighted at the factory for 25 yards. However, due to production variances between rifles, it is critical that point-of-impact be verified by sighting-in and test firing. Lasergrips are fully adjustable for windage and elevation if further adjustments are desired. A good starting point is to align the laser with your fixed sights. Shoot several sighting shots and then move the laser to line up with actual point of impact. See fig. 1 and fig. 2 on page 10.

A two-screw alignment system is used to adjust for windage and elevation. The adjustment screws are located just behind the laser aperture. See figure 9. Place the included allen wrenches into the adjustment screws. To move the laser to the left, turn the windage screw clockwise. To move the laser up, turn the elevation screw clockwise.

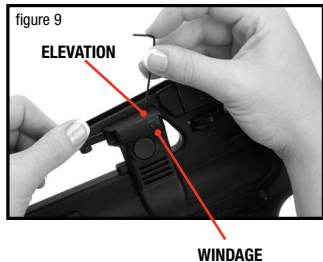

SIGHTING ADJUSTMENTS

fig. 1

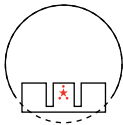

beam lined up with proper sight picture

fig. 2

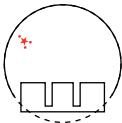

beam moved to line up with impact point

DO NOT overturn adjustment screws. A little adjustment goes a long way. Rarely is more than one complete turn required.

Occasionally, one of the adjustment screws will turn but not adjust the beam. If this happens, turn the opposite adjustment screw (i.e. windage screw if the elevation is stuck) - counterclockwise. This normally will free up the adjustment mechanism. To finish adjustment, turn the screw that was not responding first, then complete the other adjustment.

Lasergrips can be removed from the rifle for maintenance and cleaning without losing “zero”.

ADJUSTMENT TIPS

Start by tuning the beam to line up with your fixed sights at the desired distance. Most people sight in their laser at between 25 and 100 yards. However, because of the small amount of mechanical offset between the laser and the bore, the actual change in point-of-impact from these distances is very small.

Further adjustment can be made at the range to determine where your rifle impacts in relation to its fixed sights. The laser should be moved to the actual impact point of the bullet.

MAINTENANCE

Lasergrips require minimal attention and are designed to resist most common firearms chemicals and lubricants. However, excessive exposure to these chemicals can be detrimental. To ensure the safe and effective operation of your Lasergrips:

- Do not use pressurized or compressed air around laser diode housing.
- Do not immerse Lasergrips in cleaning fluid or lubricate firearm excessively. A firearm that has too much oil will foul the lens of the laser and create an unfocused beam. This can be easily cleaned and causes no permanent damage.
- Do not allow cleaning solution to enter lens area.
- Do not allow solvents to contact your grip that contain: VOCs or TCE. Such as: carb/brake cleaner, acetone, MEK, gasoline. Damage will result.

After extensive shooting, you may notice a degradation of beam quality or “beam spread”. This is the result of fouling on the lens surface. This is normal and can be easily cleaned with the included cleaning tools or a small cotton swab dipped in isopropyl alcohol or window cleaner. Dry the lens with a clean swab. **When cleaning the lens do not touch lens with any sharp objects.**

SPECIFICATIONS

- Laser Type:** Class IIIa visible laser diode
Peak Power: 5mW
Wavelength: 633nm
Beam Color: Red
Beam Size: Approx. 0.5" at 50'
Battery Type: (1) 3-Volt 123 lithium cell
Battery Life: Approx. 20 hours, 5 year shelf life



This product complies with 21 CFR 1040.10
Manufactured by Crimson Trace Corporation

WARRANTY

CRIMSON TRACE CORPORATION (CTC) warrants that this product will be free from defects in materials and workmanship for a period of three years from date of original retail purchase. CTC will repair or replace, at its option, any product or part which is found to be defective under normal use and service, without charge during the warranty period. CTC's obligation to repair or replace, shall be the purchaser's sole and exclusive remedy under this warranty. This warranty does not cover normal maintenance and service and does not apply to any products or parts which have been subject to modification, misuse, carelessness, accident, improper maintenance or repair other than by CTC. Warranty does not cover batteries or problems arising from faulty batteries.

This limited warranty is in lieu of any and all other warranties, either expressed or implied, including but not limited to, merchantability and fitness for particular purpose. CTC shall not be liable for indirect, incidental, consequential or special damages arising out of, or in connection with, product use and performance, even if it has been informed of the possibility of such damages.

For warranty service, carefully package the unit along with dated proof of purchase and an explanation of the problem, and mail it to:

Crimson Trace Corporation, Attn: Customer Service
9780 SW Freeman Drive, Wilsonville, OR 97070
Phone: (800) 442-2406



9780 SW Freeman Drive, Wilsonville, OR 97070

Phone: (800) 442-2406 or (503) 783-5333

Fax: (503) 783-5334

Customer Service E-mail: customer@crimsontrace.com

Website: www.crimsontrace.com

US Patent #5,435,091, #5,179,235, #5,706,600, #6,671,991, #6,578,311 and #6,526,688. Other patents pending.